

MOLON

officine meccaniche macchine agricole
www.molonmachinery.com

MOLON GIOVANNI s.n.c
di MOLON ENIO e BRUNO
VIA MESTRINA 10 - ARLESEGA
35035 MESTRINO - PD - ITALY
Tel. +39499000103 - Fax +39499000694
e-mail: info@molonmachinery.com

USE AND MAINTENANCE MANUAL

Machine: Hay turner and spreader

Model: **M103 GIRELLO 200**

Serial no.: **709 / 04**

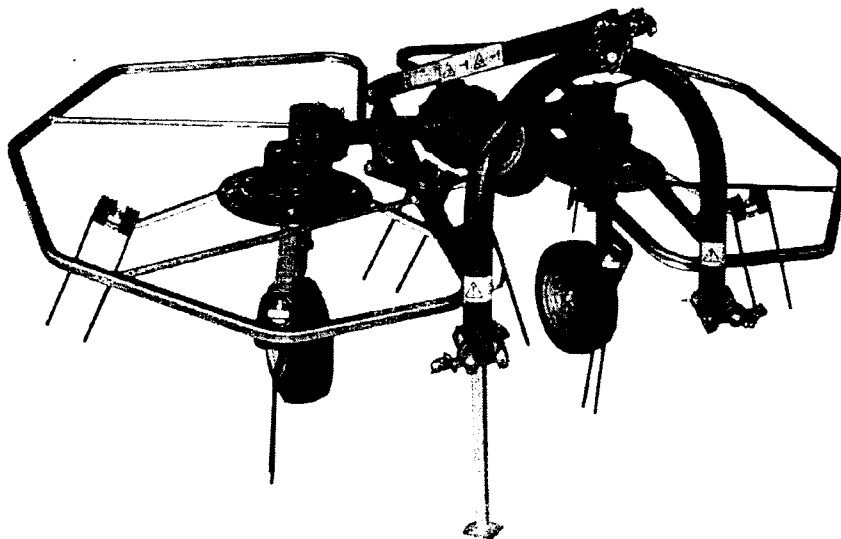

Dealer:

Delivery date:

Owner or user:

N.B: This part of the manual must be filled in at the time of delivery or installation; it is important to refer the above mentioned numbers in any communication with your dealer.

INTRODUCTION

Guide to the consultation

Congratulations on your purchase of a MOLON machine. This machine has been developed by engineers with years of experience on the field and it is built to the highest MOLON quality standards. This manual will help you to know better and to appreciate the features of your machine and it is considered integral part of the machine itself.

This machine can be relied on to last a long time without inconveniences and accidents if used in the correct way: for this reason, it is necessary to read carefully these pages before setting up and using the machine.

The manual, or a copy of it, must always be on the machine to be consulted by the user.



Pay attention to this symbol; it indicates the most dangerous operations and situations.

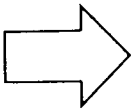

This symbol points out a note or a very important warning.

Machine identification

The machine is identified by the data which are indicated in the label.

The label is stuck on the frame and it is well visible (fig. 1); it carries the following data:

- Model**
- Serial No**
- Year**
- Weight**
- R.p.m. max./1'**

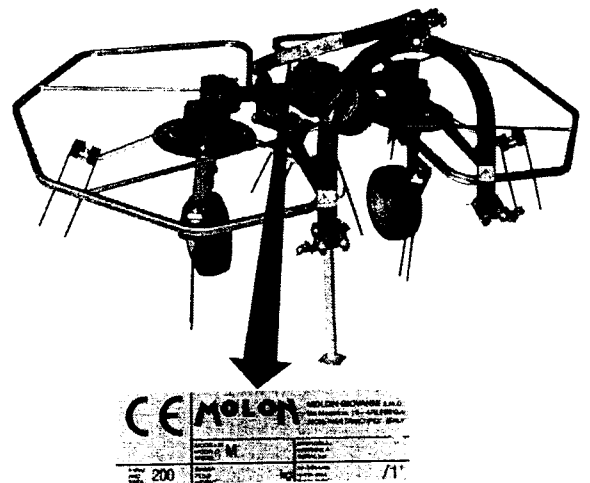

Fig. 1

WARRANTY

The warranty is valid for those parts of the machine which present manufacturing or assembly defects according to the manufacturer's opinion.

The validity of the warranty covers a period of 12 months from the date of the purchase.

The warranty does not cover the parts which are subjected to wear and tear (teeth, plastic bearings, wheels), the breaking caused by carriage, inexperience, carelessness, alteration and negligence and the possible injuries to people or things caused by the use of the machine.

The warranty declines in case of a different use from the described one.

Check the machine at the time of delivery to verify if it has been damaged during the transport.

Possible claims for damages must be put down in writing and sent to the dealer within 8 (eight) days from the delivery.

The warranty declines if the instructions given in this manual are not respected; moreover, it declines if the machine undergoes a change or if unoriginal spare parts are used.

The court of Padua is competent for every controversy.

INDEX

INTRODUCTION	page 1
Guide to the consultation	page 1
Machine identification	page 1
WARRANTY	page 2
MACHINE EMPLOYMENT	page 4
ACCIDENT PREVENTION MEASURES	page 4
USE OF THE MACHINE	page 6
Checks and advice before starting to work	page 6
The controls	page 6
Guide for the user	page 6
Adjustments for the use	page 7
Bad working and failure research	page 7
MAINTENANCE	page 8
Periodical maintenance	page 8
Teeth replacement	page 8
Extraordinary maintenance	page 9
INACTIVITY	page 9
Setting for a stop	page 9
Restarting	page 9
MACHINE TRANSPORT	page 9
TECHNICAL DATA	page 10
DEMOLITION AND GETTING RID OF MACHINE	page 10
EC DECLARATION OF CONFORMITY	page 11

MACHINE EMPLOYMENT

The machine is a hay turner and spreader. Use it only and exclusively for turning hay and cut grass.

The manufacturer declines any responsibility for a different use from the described one.

Familiarize yourself with the operating controls and the correct use of the machine.

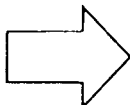
 Never permit children or inexperienced to operate your machine.



Avoid working whilst people, especially children and pets, are nearby. Keep in mind that the operator is responsible for accidents to people and to their property.

The user must know the characteristics and the safety procedures of the machine.

The accident prevention rules and any other requirement of safety and of occupational medicine must always be observed.

The manufacturer declines any responsibility for possible damages deriving from any arbitrary change on the machine.



Do not get on the machine whilst working, nor have yourself carried by it.

ACCIDENT PREVENTION MEASURES

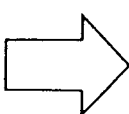
 Follow the instructions described on the labels stuck on the machine.

Scour the area where the machine is to be used and remove all foreign matters (stones, wire, sticks, etc...).

Carry out the checks, the operations of

maintenance, adjustment and repair when the machine is not working and is unhooked from the tractor.

In case of road haulage, the highway code rules have to be observed.

 Danger through rotating parts! It is absolutely forbidden to take away or to damage the guards and to use the machine without them.

 Danger through thrown objects! The machine can throw objects or stones that may lie on the ground.

 It is forbidden to stay within the working radius of 10 m.

 Do not carry out operations of cleaning or maintenance with engine on, nor with connected power take-off.

The acoustic pressure level is inferior to 70 dB.

The safety signals are (fig. 2):

A= Before the use of the machine, read the manual.

B= Danger through thrown objects; keep the safety distance.

D= Turn off the engine and take away the key before any operation of repair and maintenance.

F= Danger through rotating arms of the machine; keep the safety distance.

The corresponding labels are stuck on the machine in the indicated places. (fig. 3)

These signals must always be visible and, when lost or illegible, they have to be replaced with original ones.

Remember that a prudent operator is the best security against any accident.

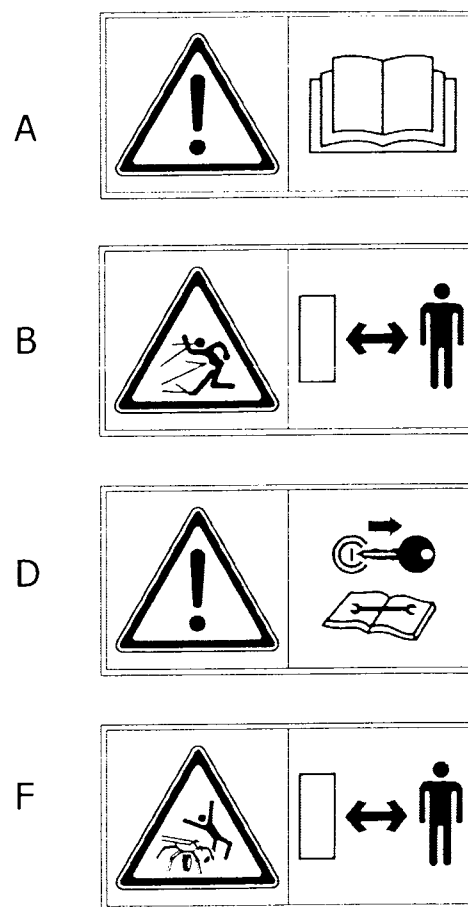

Fig. 2

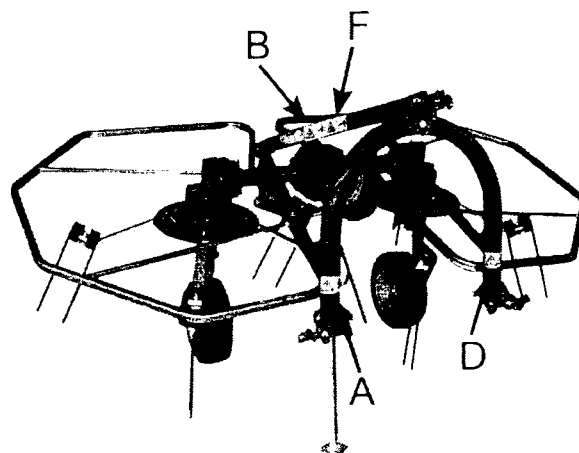

Fig. 3

USE OF THE MACHINE

Checks and advice before starting to work

The machine hooks directly to the three points of the tractor hydraulic lift.

➔ Every pin must be fixed with grip clips to avoid the unhooking.

Fasten the supporting foot, which is near the connection, in high position, far from the ground.

Connect the cardan shaft when the tractor is off and the power take-off is unconnected; control the strength of the pins which do not permit the unhooking.

The power take-off of the tractor must not exceed the speed indicated on the machine (R.P.M. max./ 1').

Make sure the cardan shaft is open no less than 4 cm in maximum closing position; in case of maximum extension, the two parts of the cardan shaft must overlap no less than 15 cm (fig. 4).

The controls

the adjustable tie-rod of the third point regulates the position of the teeth above ground level, with wheels on the ground.

Guide for the user

- Hay turner and spreader -

Adjust the height of the teeth until they skim the ground.

Connect the power take-off.

Choose the advancing speed according to hay density.

- Transport -

Lift the machine with the hydraulic lift of the tractor. To reduce the transport width, the protections can be closed and three rotor arms can be bended in the model 300, but remember to block the rotation of the rotor (fig. 5); in the mod-

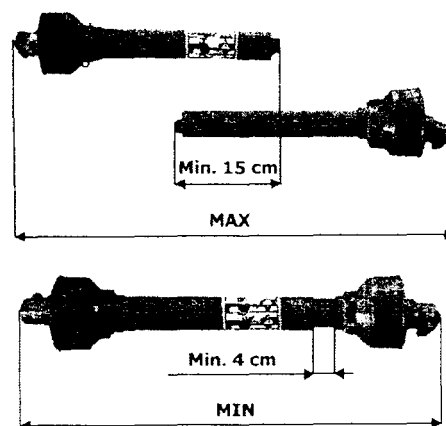

Fig. 4

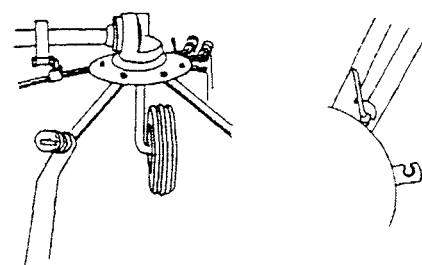

Fig. 5

els 380 and 500 the outer rotors can be bended backwards and blocked by the proper pins (fig. 6).

ARTICULATED THREE POINT LINKAGE:

The machine with articulated three point linkage behaves like a drawn one.

While working, loosen the linkage articulation to let it move freely.

➡ The maximum speed of advance is 15 Km/h.

Adjustments for the use

➡ Before starting to work, control that the teeth are in good condition and well fixed.

In case of breaking of some teeth, you must buy the original spare parts (code 1320).

Any operation on the transmission units, from the power take-off to the rotors, must be entrusted to skilled workers.

➡ Make sure that the protective sheets are correctly fixed after each operation.

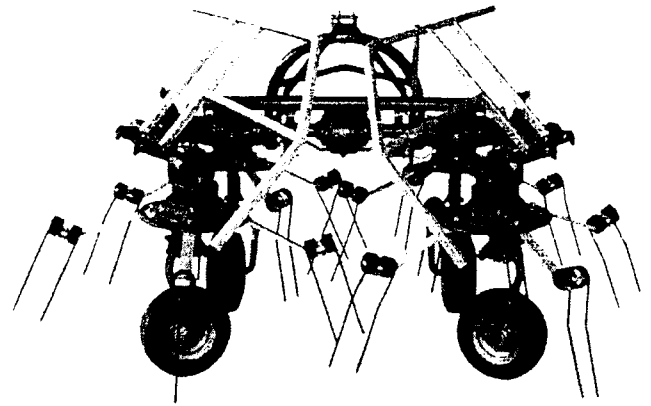

Fig. 6

Bad working and failure research

Inconvenience	Cause	Remedy	Danger
The teeth do not displace all the hay	the teeth are too high	adjust working height	keep the distance from the rotors
The teeth furrow the ground	low teeth	adjust working height	keep the distance from the rotors
The rotor arms do not turn	defects in the transmission	check by skilled workers	never operate if the machine is connected to the tractor

MAINTENANCE

Periodical maintenance

Any maintenance operation must be carried out by qualified workers according to what is written in this manual.



When you have to carry out an operation of maintenance, you must turn off the tractor engine and disconnect the power take-off.

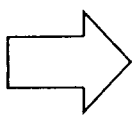

Only suitable tools must be used and they have to be in good condition.

Often grease (at least every 8 hours of work) all the parts which are provided with grease cups, particularly those located under the rotors which are not well visible (fig. 7).

Control oil level in the central box, by unscrewing the upper plug.

Substitute the whole oil after the first 40 working hours.

For this purpose you need 0,5 litres of SAE 90 oil.

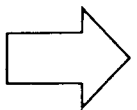

Take care of the correct getting rid of waste oil that you remove.

Control the tyre pressure (2,5 bar).



For the cardan shaft maintenance, follow the instructions given in its handbook.

Teeth replacement

To replace a couple of teeth (code 1320) you must loosen the nut which fastens it to the arm (fig. 8).

Replace the new couple of teeth and fasten the nut strongly.

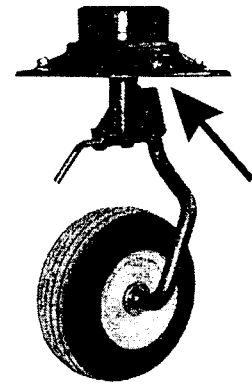

Fig. 7

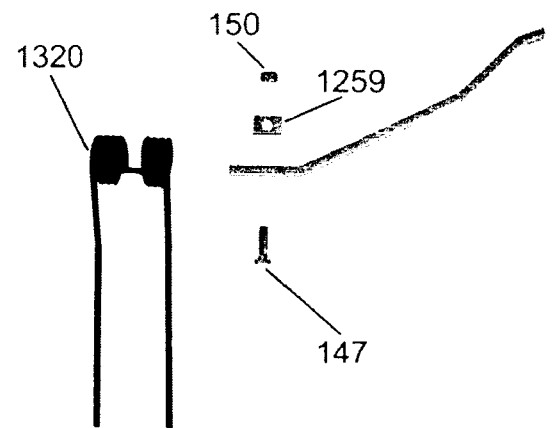

Fig. 8

Extraordinary maintenance

Any operation of extraordinary maintenance must be carried out by skilled workers and it consists on the control of the transmission units and also, if necessary, on the adjustment or replacement of the parts which are worn down.

INACTIVITY

Setting for a stop

Clean the machine when it is unhooked from the tractor and remove possible hay, remnants and dust, then do the operations of ordinary maintenance.

Block the machine to avoid displacements caused by accidental collisions.

The user will benefit from finding the machine in perfect conditions when he starts working again.

Restarting

Control the tyre pressure (2,5 bar).

MACHINE TRANSPORT

The machine can easily be lifted by a crane through two belts, type-tested for its weight, which must be placed, the first on the three point connection and the other on the pipes that connect the central reducer to the lateral heads (fig. 9).

The points of belt placement are indicated on the machine by proper labels (fig. 13).

For the operations of loading and unloading, the machine must be placed on a level ground with sufficient surrounding space.

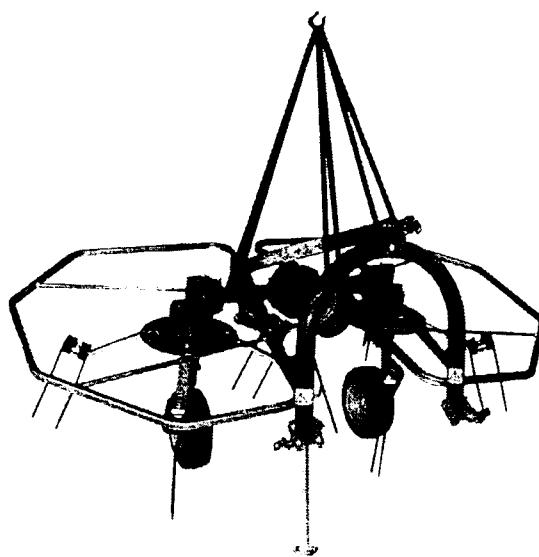

Fig. 9

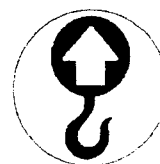

Fig. 10

Technical data

Model	Rotors no.	Rotor arms no.	Working width cm	Minimum width cm
GIRELLO 200	2	4	200	200
GIRELLO 250	2	6	250	250
GIRELLO 300	2	6	300	200
GIRELLO 380	4	4	380	200
GIRELLO 500	4	6	500	250

DEMOLITION AND GETTING RID OF THE MACHINE

Proceed to demolition and getting rid of the machine according to the regulations in force so as to avoid ecological damages.

Take care of the correct getting rid of the waste oil before the demolition.

EC DECLARATION OF CONFORMITY

MOLON GIOVANNI s.n.c.

Via Mestrina 10

35035 MESTRINO PD ITALY

We declare on our exclusive responsibility that the product:

HAY TURNER AND SPREADER

GIRELLO 200 FPZ

GIRELLO 250 FPZ

GIRELLO 300 FPZ

GIRELLO 380 FPZ

GIRELLO 500 FPZ

to which this declaration refers is in conformity with the following standards and other normative documents EN 292/92 and UNI 94/56 following the provisions of 89/392/EEC Directive.

Mestrino 16/01/1995

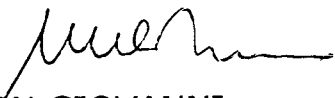

MOLON GIOVANNI s.n.c.